

UNI-T®

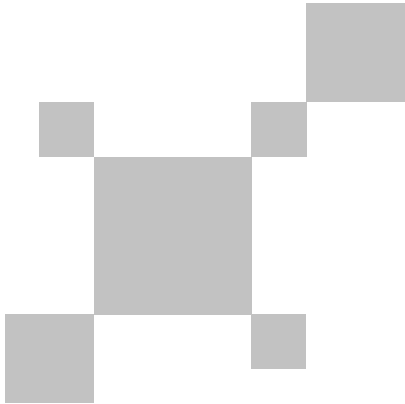

**UTi260E**  
**红外热成像仪**  
**Professional Thermal Imager**

P/N:110401110344X

**UTi260E**  
**红外热成像仪使用说明书**  
(4p-22p)

**UTi260E**  
**Professional Thermal Imager**  
**User Manual**  
(24p-40p)

## 序言

尊敬的用户：

您好！感谢您选购全新的UTi260E红外热成像仪，为了正确使用本产品，请您在使用之前仔细阅读本说明书全文，特别是有关“安全注意事项”的部分。

如果您已经阅读完本说明书全文，建议您将此说明书妥善保管，与红外热成像仪配件一同放置或者放在您随时可以查阅的地方，以便在将来的使用过程中查阅。

## 有限担保和有限责任

公司担保本产品自购买之日起一年内，在材料和工艺上均无任何缺陷。本担保不适用于由于意外、疏忽、误用、改装、污染及非正常操作或处理引起的损坏。经销商无权以公司的名义给予其它任何担保。如在保修期内需要保修服务，请与您就近的授权服务中心联系，获得产品退还授权信息；然后将产品寄至该服务中心，并附上产品问题描述。

本项担保是您能获得的最佳补偿。除此以外，公司不提供任何明示或隐含的担保，例如适用于某一特殊目的的隐含担保。同时，公司不对基于任何原因或推测而导致的任何特殊、间接、附带或继起的损坏或损失负责，由于某些州或国家不允许对默认担保及附带或继起的损坏加以限制，故上述的责任限制与规定或许对您不适用。

## 目录

1. 性能指标	6
2. 构造	7
3. 显示说明	8
4. 开关机	8
5. 配置菜单说明	9
6. 标记工具	10
7. 图像模式	10
8. 色板切换	11
9. 测温工具	11
10. 色条工具	13
11. 系统设置	13
11.1 相机模式	13
11.2 单位	13
11.3 参数	14
11.4 报警	14
11.5 QR CODE	15
11.6 语言	16
11.7 日期, 时间	16
11.8 Wi-Fi	16
11.9 USB模式	17
11.10 亮度	17
11.11 自动关机	17
11.12 恢复出厂	18
11.13 关于	18
12. 照片浏览	18
13. 按键	19
14. SD 卡	19
15. 保养	20
16. 安全须知	20
17. 常用发射率	20

## 1. 性能指标

传感器	非制冷氧化钒	图像抓取模式	拍照、自动拍照
温度档位	低温档 (-20°C~150°C) 高温档 (0°C~550°C) (手动切档)	图像保存格式	JPG
显示屏幕	3.5" IPS	图像浏览	可温度分析、变更色板、备注
显示分辨率	640*480	二维码扫描	有
发射率	0.95 (默认) 0.01~1.00	USB通讯	Type-C USB (实时图像及U盘存储)
热成像像素	256*192 (49152)	WiFi	有
可见光像素	200万	PC投屏	有
热成像像素大小	12um	PC分析软件	有 (实时图像、照片下载及分析)
色板	铁红、彩虹、黑热、白热、 红热、熔岩、高对比度彩虹	手机APP	有 (照片下载及分析)
红外光谱带宽	8~14um	LED照明	有
视场角	56°*42.2°	语言	中文/English
IFOV	3.8mrad	认证	CE FCC
镜头焦距	3.2mm	工作温度	0°C~50°C (32°F~122°F)
调焦模式	免调焦	存储温度	-10°C~60°C (14°F~140°F)
灵敏度	<50mK @25°C	工作湿度	10%~95%RH (非冷凝)
帧频率	<25Hz	精度	-10°C~550°C, 常温25°C, ±2°C/±2%取大值
数码放大	2x, 4x	温度测量范围	-20°C~550°C (-4°F~1022°F)
温度分析	5点, 3区域 (大, 中, 小), 1线 (画面最多6个)	电池	5200mAh (可拆电池包)
等温线	手动/自动	自动关机	0~90min
测温显示	中心点温度、高/低温追踪	使用时间	大于3h
测温单位	摄氏度 (默认)、华氏度	充电时间	小于4h
高低温报警	有 (LED照明报警、LCD 动画报警)	充电电压/ 电流	5V/1.5A 9V/1A 12V/1A (仅QC2.0以下标准USB充 电头情况下支持)
图像模式	热成像、可见光、融合、画中画	图像存储	Micro SD卡最大支持32G
		防护等级	IP54, 2米跌落

## 2. 结构

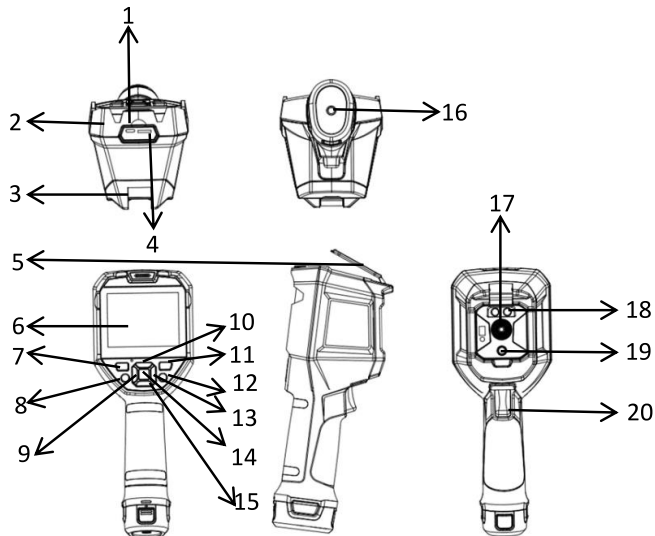

项目	说明	项目	说明
1	USB Type-C接口	11	照片浏览键
2	上壳	12	返回键
3	下壳	13	右键
4	SD卡槽	14	SET键
5	接口保护盖	15	下键
6	液晶显示屏	16	支架固定螺孔
7	开机键	17	红外热像窗口
8	照明键	18	照明灯
9	左键	19	可见光摄像窗口
10	上键	20	拍照扳机键

## 3. 显示说明

显示屏尺寸：640×480

显示器分辨率：256(垂直)×192(水平)



项目	说明	项目	说明
1	标记工具	8	自动追踪最小点
2	图像模式	9	色温条
3	色板切换	10	色板范围上限
4	测温工具	11	电量
5	色条工具	12	温度测量中心点温度
6	系统设置	13	自动追踪最大点
7	色板范围下限	14	温度测量中心点

## 4. 开关机

长按“开机键”5秒，热像仪开机（刚开机、长时间未使用或测量环境改变后需要开机30分钟后才能进行温度测量）；长按“开机键”5秒，热像仪关机。当热像仪处于低电量模式时，弹出电量过低的提示，此时需要关闭热像仪，补充电量；当热像仪一直处于低电量模式，热像仪会自动关机。

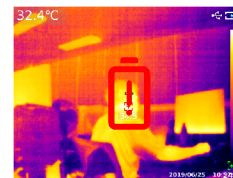

## 5. 配置菜单说明

### 主菜单配置选项

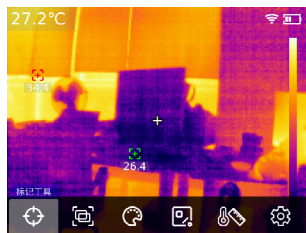

热像仪主页面

1. 在主页面按“SET键”弹出主菜单
2. 按“左/右键”选择子菜单
3. 按“SET键”确定进入相应子菜单
4. 按“左/右键”选择子菜单设置项
5. 按“SET键”选择设置
6. 按“返回键”返回上级并保存设置
7. 再次按“返回键”返回热成像主页面

### 主菜单



### 子菜单



## 6. 标记工具

若需要使用中心点/高低温追踪/温度值显示功能，按“SET键”弹出主菜单选项，通过“左/右键”选中“标记工具”，再按“SET键”进入标记工具子菜单选项，通过“左/右键”进行选择。（例如：按“SET键”选中“中心点”，当出现十字准心时表示打开了中心点光标，再次按“SET键”，十字准心消失，表示关闭了中心点光标的功能。）

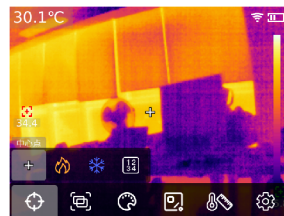

## 7. 图像模式

按“SET键”弹出主菜单选项，通过“左/右键”选中“图像模式”，再按“SET键”进入图像模式子菜单选项，通过“左/右键”进行选择；按“SET键”选中“热成像”，图像切换为热成像模式；按“SET键”选中“可见光”，图像切换为可见光模式；按“SET键”选中“融合图”，图像切换为融合模式（该模式下可通过“左/右键”进行融合比例的调节，通过“上/下键”进行融合距离的调节）；按“SET键”选中“画中画”，图像切换为画中画模式，通过“左/右键”选择移动或拉伸，来改变画中画的位置和大小；按“SET键”选中“二维码”，可以手动输入二维码或扫码获取二维码，选择“取消”则返回主页面。



## 8. 色板切换

按“SET键”弹出主菜单选项，通过“左/右键”选中“色板切换”，通过“左/右键”选择所需要的色板，有白热、红热、铁红、黑热、高彩虹、熔岩、彩虹七种色板可选。

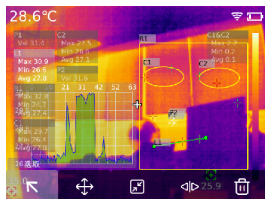
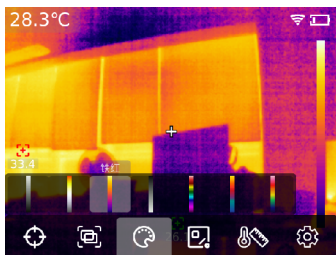

按“SET键”选中清空全部的功能后，会清空当前页面的全部测温分析对象；当主页面存在测温分析对象时，按“SET键”选中预设工具，将会弹出“保存工具”的提示框，如果选择确认，则保存当前分析对象，则下次可直接使用该预设工具。若主页面无测温分析对象，按“SET键”选择预设工具，则弹出“读取工具”的提示框，选择确认，会将上次保存的预设工具添加到主页面。

## 9. 测温工具

按“SET键”弹出主菜单选项，通过“左/右键”选中“测温工具”，通过“左/右键”选择需要的分析对象类型（按“SET键”添加，包括点测温、线测温、矩形、圆形）以及选取目标（只有主页面中添加了分析对象时才能使用该功能）、清空全部、预设工具。

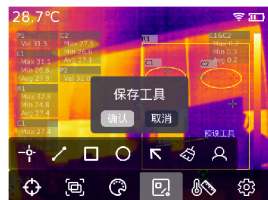
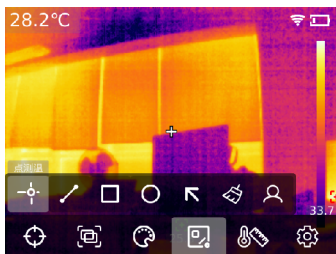

注意：点测温分析对象最多添加5个，线测温分析对象只能添加1个，矩形和圆形测温分析对象最多可以添加3个。添加的总测温分析对象数量不能超过6个，当超过6时则不再添加分析对象，并弹出提示“超出工具数目”。

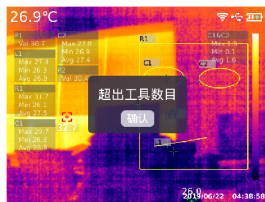

按“SET键”添加了点、线、矩形、圆形测温分析对象之后，会自动弹出“选取目标”的子菜单栏，通过“左/右键”选择需要的功能，包括选取、移动、拉伸（点测温分析对象不能进行拉伸）、对比（点测温分析对象只能与点测温分析对象进行对比，进行对比后将会在右侧显示相应的对比信息）、删除（只能删除当前所选中的测温分析对象）的功能。添加测温分析对象之后，会在左侧显示相应的温度信息；当线测温分析对象被选中时，会在左下角显示该线区域温度曲线变化图。

## 10. 色条工具

按“SET键”弹出主菜单选项，通过“左/右键”选中“色条工具”，通过“左/右键”选择所需要的色条工具，有自动等温、比例等温、向下等温、向上等温、区间等温、手动等温六种模式可选。

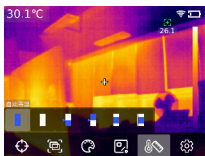

## 11. 系统设置

按“SET键”进入子菜单，通过“上键/下键”选择不同设置，按“SET键”进入设置二级页面进行设置，包括：相机模式、单位、参数、报警、QR CODE、语言、日期、时间、无Wi-Fi、USB模式、亮度、自动关机、恢复出厂、关于的设置。点击“返回键”返回设置页面一级菜单，再次点击“返回键”返回主菜单。

### 11.1 相机模式

进入设置页面一级菜单后，选中“相机模式”选项，按“SET键”进入“相机模式”子菜单，通过“上/下键”选择拍照/自动拍照。若选择自动拍照，通过“上/下键”选择自动拍照时间间隔（10S-1000S可选）。



### 11.2 单位

进入设置页面一级菜单后，选中“单位”选项，按“SET键”进入“单位”子菜单，通过“上/下键”选择温度/距离。选择温度时，通过“上/下键”选择需要的温度单位（°F/°C）；距离单位不可改。



### 11.3 参数

进入设置页面一级菜单后，选中“参数”选项，按“SET键”进入“参数”子菜单，通过“上/下键”选中发射率/环境温度/反射温度/湿度/目标距离/档位切换，按“SET键”选择需要更改的参数，通过“上/下键”选择所需参数的数值。当设置目标距离参数时，按“SET键”进入“目标距离”子菜单，再通过“SET键”和“上/下键”进行参数的修改。

低温档测温范围：-20~150°C

高温档测温范围：0~550°C

**注意：**设备在进行档位切换过程中需要耗时20S左右，请等待切换稳定后再进行其他操作或测温。



1. 请参考20页发射率表；
2. 如果不确定选用哪些值，建议使用以下默认值  
 发射率 0.95  
 环境温度 25°C  
 反射温度 25°C  
 湿度 55%RH  
 目标距离 0.25m

**注意：**发射率和反射温度中是需要正确设定的两个最重要参数，如果不确定，请采用默认值。

### 11.4 报警

进入设置页面一级菜单后，选中“报警”选项，按“SET键”进入“报警”子菜单，通过“上/下键”选中高温报警/低温报警/LED报警。当选择高温报警/低温报警时，通过“上/下键”选中高/低温报警数值，按“SET键”选择，通过“上/下键”设置所需要的数值（-20°C~550°C可选）。





当被测物温度超过高温报警温度值时，弹出红色正三角的提示；当被测物温度低于低温报警温度值时，弹出绿色倒三角的提示。



## 11.5 QR CODE

进入设置页面一级菜单后，选中“QR CODE”选项，按“SET键”进入“QR CODE”子菜单，通过“上/下键”选中不同的QR CODE，按“SET键”进入QR CODE名称/CODE的更改。

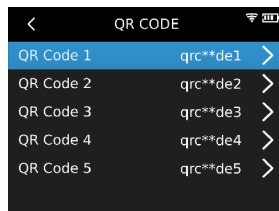

## 11.6 语言

进入设置页面一级菜单后，选中“语言”选项，通过“上/下键”选择中文简体/English。



## 11.7 日期, 时间

进入设置页面一级菜单后，选中“日期, 时间”选项，按“SET键”进入“日期时间”子菜单，按“SET键”选择更改时制/日期/时间，通过“上/下键”更改具体数值。例如，日期更改，通过“左/右键”选择年/月/日的更改，通过“上/下键”选择具体日期。



## 11.8 Wi-Fi

进入设置页面一级菜单后，选中“Wi-Fi”选项，按“SET键”进入子菜单。按“SET键”打开热点，按“下键”选择热点ID和密码，通过“SET键”选中中进行设置。



### 11.9 USB模式

进入设置页面一级菜单后，选中“USB模式”选项，按“SET键”进入“USB”子菜单，通过“上/下键”选中USB存储/USB投影，按“SET键”选择。



### 11.10 亮度

进入设置页面一级菜单后，选中“亮度”选项，通过“上/下键”选择亮度强弱（1-100可选）。

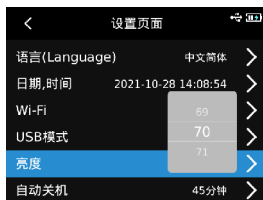

### 11.11 自动关机

进入设置页面一级菜单后，选中“自动关机”选项，通过“上/下键”选择关闭/5分钟/10分钟/20分钟/30分钟/45分钟/60分钟/90分钟。



### 11.12 恢复出厂

进入设置页面一级菜单后，选中“恢复出厂”选项，按“SET键”，弹出提示“关机恢复出厂”，选择是，将自动关机，手动开机后，仪器恢复出厂设置。

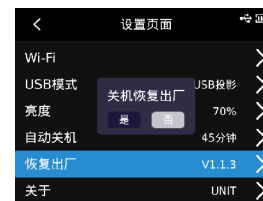

### 11.13 关于

进入设置页面一级菜单后，选中“关于”选项，按“SET键”进入“产品讯息”子菜单，可查看产品型号、红外分辨率、硬件版本、系统版本、SD容量等相关产品信息。



## 12. 照片浏览

在主页面，按“照片浏览键”，进入多媒体浏览。按“上/下键”选择全部照片/影片或其他文件夹，按“SET键”进入。按“上/下/左/右键”选择要查看的图片，“SET键”查看图片，通过“左/右键”可以切换图片。按“SET键”出现图片界面子菜单，按“左/右键”选择照片讯息（可查看图片的拍摄时间，修改时间，发射率，红外分辨率，环境温度，湿度，反射距离以及二维码，备注等信息）、修改备注（添加备注后，可以在照片讯息中进行查看）、态编辑（可以在原有的图片上进行标记工具、图像模式、色板切换、测温工具、色条工具等功能的二次编辑，功能与主页面功能基本保持一致）、二维码（可添加现有的二维码进行图片分类，分类后可在不同的文件夹查看相应二维码分类的图片，也可以删除当前图片的二维码或添加新的二维码，此处新添加的二维码未进行文件夹分类）、删除照片的功能。

注意：在状态编辑页面进行编辑之后，按“SET键”打开状态编辑子菜单，通过“上键”选择恢复，按“SET键”使图片恢复到初始状态。进行编辑后，按“返回键”，弹出提示“是否退出？”，若选择退出，则直接退出编辑页面；若选择保存，则弹出提示“是否覆盖？”，选择覆盖，更改原图并保存后，返回浏览页面；若选择新建，则不更改原图，新增加一张更改后的图片并返回浏览页面。

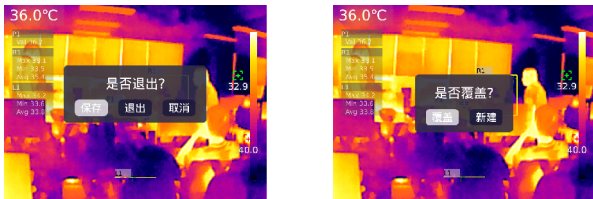

在添加二维码后，按“返回键”弹出提示“保存并退出”选择确认，则保存所添加的二维码，选择取消则不保存且退出二维码编辑页面。此处添加的二维码不会保存到已有的二维码分类中，如果要修改已有的二维码，则需要在设置中进行更改。

## 13. 按键

在主页，按“上键”，屏幕画面进行放大，对应的放大倍数显示于屏幕右上角，放大倍数的切换按照1X、2X、4X、1X循环切换。

在主页，按“左右键”，可以进行融合程度的调节，融合调节程度分别为0%、25%、50%、75%、100%。

## 14. SD卡

本设备支持Micro SD卡存储图像，为了避免图像数据过大影响运行速度，请定期拷贝备份数据，并及时清理卡内数据。为了避免热拔插造成SD卡数据异常，请不要反复拔插SD卡，尽量在关机状态下拔插SD卡。若在图像浏览页面拔掉SD卡，则会弹出提示“SD卡丢失”。



## 15. 保养

用湿布或弱肥皂液清洗结构外壳，不要使用研磨机、异丙醇或溶剂清洁仪器外壳镜头/窗口。

## 16. 安全须知

为了保证测量结果准确，请仔细阅读使用说明。请务必按照说明书使用本产品，否则造成产品损坏后将不进行免费保修。请不要在易燃易爆、蒸汽周围、潮湿或腐蚀性环境下使用本仪器、请不要在仪器损坏、摔坏或修正后的情况下继续使用，以免造成错误的测试结果。请参考辐射系数信息获取实际温度，否则会导致测得的温度不准确。

严禁将镜头瞄准强热光源，如太阳等高温目标，以免造成镜头或热成像探测器损坏。

请勿在极热、极冷、多尘或者高湿度的环境下使用产品，具体温度、湿度要求参见产品的参数表。

系统支持USB线对机器充电，但为了提升充电效率，建议拔出电池包，单独对电池包充电。

## 17. 常用发射率

材质	发射率	材质	发射率
木	0.85	黑纸	0.86
水	0.96	聚碳酸	0.8
砖	0.75	混凝土	0.97
不锈钢	0.14	氧化铜	0.78
胶带	0.96	铸铁	0.81
铝板	0.09	锈	0.8
铜板	0.06	石膏	0.75
黑铝	0.95	油漆	0.9
人体皮肤	0.98	橡胶	0.95
沥青	0.96	土壤	0.93
PVC塑料	0.93		

\*本说明书内容若有变更，恕不另行通知\*

**优利德®**

**优利德科技(中国)股份有限公司**

地址：广东省东莞市松山湖园区工业北一路6号

电话：(86-769) 8572 3888

邮编：523 808

<http://www.uni-trend.com.cn>

## **PREFACE**

Thank you for purchasing the new UTi260E Professional Thermal Imager. In order to use this product safely and correctly, please read this manual thoroughly, especially the Safety Instructions part.

After reading this manual, it is recommended to keep the manual at an easily accessible place, preferably close to the device, for future reference.

## **LIMITED WARRANTY AND LIABILITY**

Uni-Trend guarantees that the product is free from any defect in material and workmanship within one year from the purchase date. This warranty does not apply to damages caused by accident, negligence, misuse, modification, contamination and improper handling. The dealer shall not be entitled to give any other warranty on behalf of Uni-Trend. If you need warranty service within the warranty period, please contact your seller directly.

This warranty is the only compensation you can obtain. Uni-Trend will not be responsible for any special, indirect, incidental or subsequent damage or loss caused by any reason or speculation. As some areas or countries do not allow limitations on implied warranties and incidental or subsequent damage, the above limitation of liability and stipulation may not apply to you.

## TABLE OF CONTENTS

1. Technical Specifications -----	24
2. Product Structure -----	26
3. LCD Indicators/Icons -----	27
4. Power on/off -----	27
5. Menus -----	28
6. Markup -----	29
7. Image -----	29
8. Palette -----	30
9. Measure -----	30
10. Isotherm -----	32
11. System -----	32
11.1 Camera Model -----	32
11.2 Units -----	32
11.3 Parameter -----	33
11.4 HI/LO Alert -----	33
11.5 QR CODE -----	34
11.6 Language -----	35
11.7 Date & Time -----	35
11.8 Wi-Fi -----	35
11.9 USB Mode -----	36
11.10 Brightness -----	36
11.11 Auto power off -----	36
11.12 Factory Reset -----	37
11.13 About -----	37
12. Image Viewing -----	37
13. Buttons -----	38
14. SD Card -----	38
15. Maintenance -----	39
16. Safety Instructions -----	39
17. FCC Compliance statement -----	39
18. Common Emissivity -----	40

## 1. Technical Specifications

Sensor	Uncooled vanadium oxide
Temperature Scale	Low temperature (-20°C~150°C) High temperature(0°C~550°C) (Manual switch)
Display	3.5" IPS
Display resolution	640*480
Emissivity	0.95 (default) 0.01~1.00
Thermal imaging pixels	256*192 (49152)
Visible light pixels	2 million
Pixel size	12µm
Palettes	iron,Rainbow,whitehot,redhot,blackhot,lava,Rain.HC.
Infrared spectrum bandwidth	8~14µm
Field of view	56°*42.2°
IFOV	3.8mrad
Lens focal length	3.2mm
Focus mode	Focus free
Sensitivity	<50mK @25°C
Frame rate	<25Hz
Digital zoom	2x,4x
Temperature analysis	Point, areas (large, medium and small), line (up to 6 analysis objects can be added at the same time)
Isotherm	Manual/auto
Temperature display	Center point temperature, high/low temperature tracking
Unit	°C (default)/°F
High and low temperature alarm	√ (LED alarm, LCD alarm)
Image modes	Thermal, visible, fusion, PIP
Image capture mode	Photograph/self-timer
Image save format	JPG
Image viewing	Temperature analysis, change palettes, remarks

QR code scanning	√
USB communication	Type-C USB (real-time image and U disk storage)
WIFI	√
PC screen projection	√
PC analysis software	√ (real-time image, photo download and analysis)
Mobile APP	√ (photo download and analysis)
Flashlight	√
Language	Chinese/English
Certificates	CE FCC
Operating temperature	0°C~ 50°C (32°F~ 122°F)
Storage temperature	-10°C~ 60°C (14°F~ 140°F)
Operating humidity	10%~95%RH (non-condensing)
Accuracy	-10°C~550°C, normal temperature 25°C, ±2°C/±2% (whichever is greater)
Measurement range	- 20°C ~ 550°C (-4°F~1022°F)
Battery	5200mAh (removable battery pack)
Auto power off	0~90min
Operating time	>3h
Charging time	<4h
Charging voltage/current	5V/1.5A 9V/1A 12V/1A (only for USB charging heads below QC2.0 standard)
Image storage	Micro SD card, maximum 32G
IP rating	IP54, 2m drop proof

## 2. Product Structure

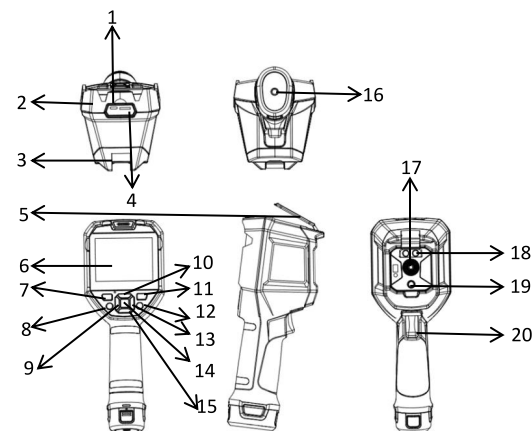

Item	Description	Item	Description
1	USB Type-C interface	11	View images
2	Upper housing	12	Return
3	Lower housing	13	Right
4	SD card slot	14	SET
5	Interface protection cover	15	Down
6	LCD	16	Bracket screw hole
7	Power	17	Infrared camera lens
8	Flashlight button	18	Flashlight
9	Left	19	Visual light camera lens
10	Up	20	Trigger

### 3. LCD Indicators/Icons

Display size: 640×480

Display resolution: 256 (vertical) × 192 (horizontal)

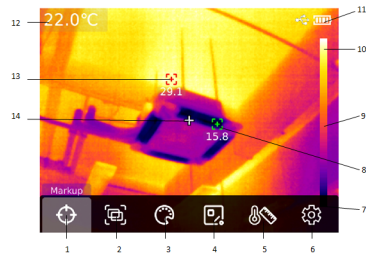

Item	Description	Item	Description
1	Markup	8	Lowest temperature spot
2	Image	9	Range bar
3	Palette	10	Upper range of palette
4	Measure	11	Battery status
5	Vitta	12	Center point temperature
6	System	13	Highest temperature spot
7	Lower range of palette	14	Center point marker

### 4. Power on/off

Long press the power button for 5s to turn on/off the thermal imager (it needs 30 minutes warm-up time when the device is just turned on or not used for a long time, or the measurement environment changes). When the battery is low, a low battery indicator will show on the LCD, which means the thermal imager should be turned off and the battery should be charged. When the thermal imager is in low battery status for a long time, the device will automatically shut down.



### 5. Menus

Main Menu Configuration Options

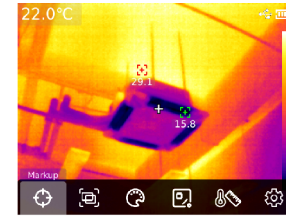

In the main interface:

1. Press the SET button to open the main menu.
2. Press the left/right button to step through submenus.
3. Press the SET button to open the selected submenu.
4. Press the left/right button to step through setting items in the submenu.
5. Press the SET button to confirm the selected setting item.
6. Press the return button to return to the previous interface and save the setting.
7. Press the return button again to return to the main interface.

#### Main Menu



#### Submenu

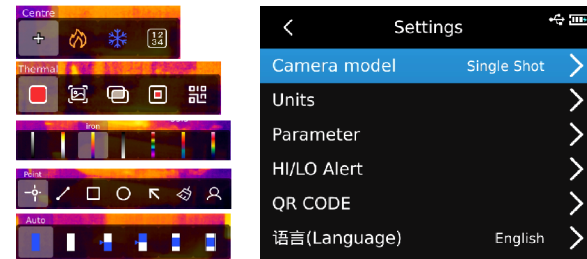



## 6. Markup

In the main interface, press the SET button to open the main menu. Press the left/right button to select "Markup". Press the SET button again to open the submenu of "Markup". In the submenu, press the left/right button to select a submenu option. (For example: press the SET button to perform the selected function "Center", and a center point marker will show on the middle of the screen. Press the button again to exit.)

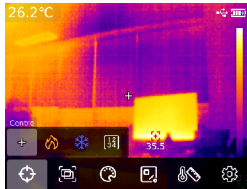

## 7. Image

In the main interface, press the SET button to open the main menu. Press the left/right button to select "Image". Press the SET button again to open the submenu of "Image". In the submenu, press the left/right button to select a submenu option. (For example: press the SET button to perform the selected function "Fusion" and the image will switch to the fusion mode.) In the fusion mode, press the left/right button to adjust the mix proportion, and up/down button to adjust the mix distance. In the PIP mode, press the left/right button to move the position or stretch the size of PIP. As for the QR function, users can manually input the QR code or scan the QR code. Select "cancel" to return to the main interface.

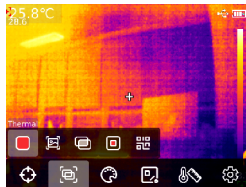

## 8. Palette

In the main interface, press the SET button to open the main menu. Press the left/right button to select "Palette". Press the SET button again to open the submenu of "Palette". Press the left/right button to step through seven optional palettes: iron, Rainbow, whitehot, redhot, blackhot, lava, Rain.HC.

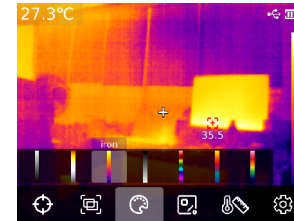

## 9. Measure

In the main interface, press the SET button to open the main menu. Press the left/right button to select "Measure". Press the SET button again to open the submenu of "Measure".

In the submenu, press the left/right button to select an analysis object (Point, Line, Rect., Circle). Press the SET button to add the selected object. The submenu also includes three other functions: choose (this function can only be used if an analysis object is added), clear, preset.

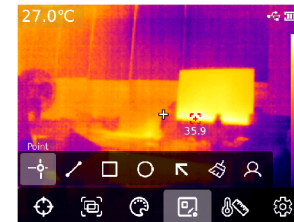

After adding an analysis object, a submenu will appear. The optional functions in the submenu are choose, move, stretch (this function cannot be applied to point objects), diff (point objects can only be compared with point objects; the comparison information will be displayed on the right side), delete (delete the selected object). The temperature information of the added object will be displayed on the left. When a line object is selected, its temperature change graph will be displayed in the lower left corner.

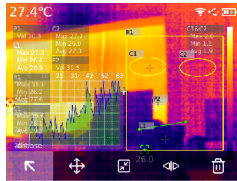

Press the "SET" button to perform the "clear" function, and all the analysis objects in the current interface will be cleared. When there is an analysis object, press the "SET" button to perform the "preset" function, and a box "Save tool" will pop up. Select "OK" to save the analysis object. The preset tool can be used directly next time.

If there is no temperature measurement and analysis object on the main page, press the "SET" button to select a preset tool, and a prompt box of "Read tool" will pop up. Select Confirm, and the preset tool saved last time will be added to the main page.

When there is no analysis object in the main interface, press the "SET" button to perform the "preset" function, and a box "Read tool" will pop up. Select "OK" and the preset tool will be added to the interface.

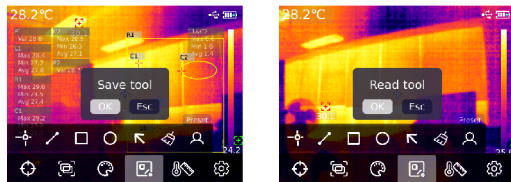

Note: The maximum number of point objects that can be added is 5 (line: 1; Rect.: 3; circle: 3). The total number of analysis objects added cannot exceed 6. When it exceeds 6, a box "Outnumber" will pop up.

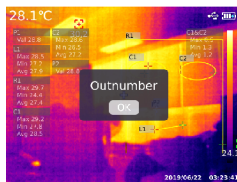

## 10. Isotherm

In the main interface, press the SET button to open the main menu. Press the left/right button to select "Isotherm". Press the SET button again to open the submenu of "Isotherm". The options in the submenu are: Auto, Ratio, Below, Above, Section, Manual.

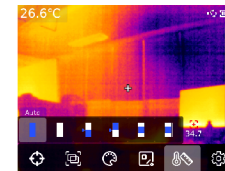

## 11. System

Press the SET button to enter the submenu. Press the up/down button to select a setting item, and press the SET button to enter the interface of this item.

### 11.1 Camera Model

In the setting interface, select "camera model" and press the SET button to enter the submenu. Press the up/down button to select Single Shot/Time-lapse. In the Time-lapse mode, press the up/down button to adjust the Time-lapse interval (10s-1000s).

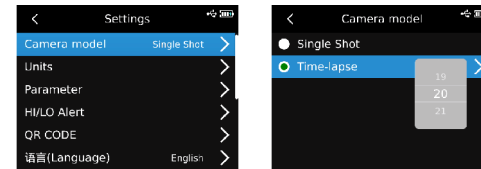

### 11.2 Units

In the setting interface, select "units" and press the SET button to enter the submenu. Press the up/down button to select temperature/distance. When selecting temperature, press the up/down button to change the units (°F/°C). The distance unit cannot be changed.

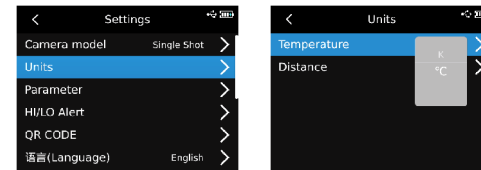

### 11.3 Parameter

In the setting interface, select "parameter" and press the SET button to enter the submenu. Press the up/down button to select Emissivity/Ambient Temp./Reflected Temp./Relative Humidity/ObjectDistance/Temperature Scale. Press the SET button to select the parameter to be modified, and press the up/down button to adjust the parameter value. When setting the object distance, press the SET button to enter its submenu, and then press the SET button and the up/down button to modify the parameter.

Low temperature:-20°C~150°C

High temperature:0°C~550°C

Note:It takes about 20S to switch mode.

Please wait until it is stable and take the next action.

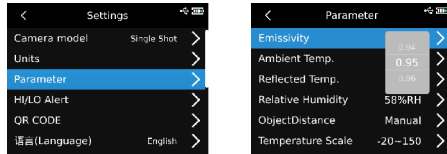

1. Please refer to emissivity table on page 40;
2. If you are not sure which value to use, use the following default values  
 Emissivity 0.95  
 Ambient Temp. 25°C  
 Reflected Temp. 25°C  
 Relative Humidity 55%RH  
 ObjectDistance 0.25m

**Note: Emissivity and reflection temperature are the two most important parameters to set correctly. If in doubt, use the default values.**

### 11.4 HI/LO Alert

In the setting interface, select "HI/LO Alert " and press the SET button to enter the submenu. Press the up/down button to select HI/LO/LED Alert. When setting HI/LO, press the up/down button to select HI value/LO value, press the SET button to modify, and press the up/down button to adjust the value (-20°C~550°C).

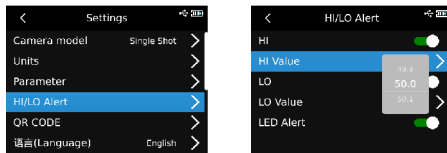

When the measured temperature exceeds the HI value, a red triangle will pop up. When the measured temperature is lower than the LO value, a green inverted triangle will pop up.



### 11.5 QR CODE

In the setting interface, select "QR code" and press the SET button to enter the submenu. Press the up/down button to select a QR code. Press the SET button to change the code name or reset the code.

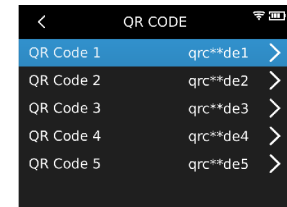
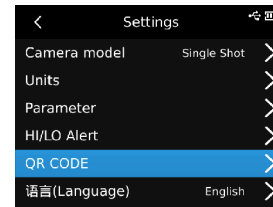

## 11.6 Language

In the setting interface, select "Language" and press the up/down button to select Simplified Chinese/English.

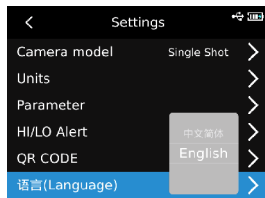

## 11.7 Date & Time

In the setting interface, select "Date & Time" and press the SET button to enter the submenu. Press the SET button to modify Time format/Date/Time, and press the up/down button to adjust the value.

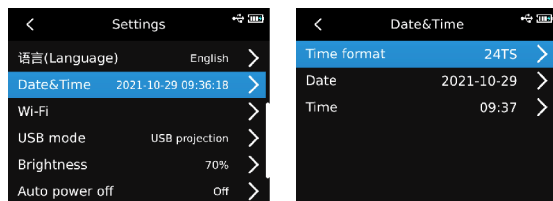

## 11.8 Wi-Fi

In the setting interface, select "Wi-Fi" and press the SET button to enter the submenu. Press the SET button to turn on the LionScripts, press the down button to select the ID and password, and press the SET button to confirm.

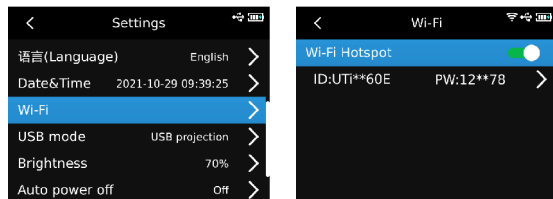

## 11.9 USB mode

In the setting interface, select "USB mode" and press the SET button to enter the submenu. Press the up/down button to select USB storage/USB projection, and press the SET button to confirm.

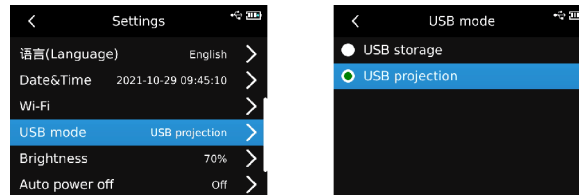

## 11.10 Brightness

In the setting interface, select "Brightness" and press the up/down button to adjust the brightness (1-100).

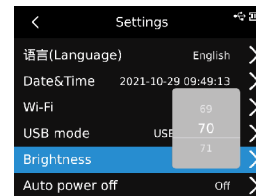

## 11.11 Auto power off

In the setting interface, select "Auto power off" and press the up/down button to select Off/5min/10min/20min/30min/45min/60min/90min.

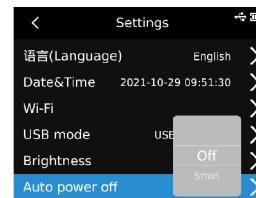

### 11.12 Factory Reset

In the setting interface, select "Factory reset" and press the SET button. A box "Factory reset?" will pop up. Select "Yes", the device will automatically shut down. After turning on again, the device will restore the factory settings.

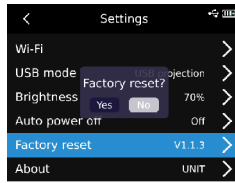

### 11.13 About

In the setting interface, select "About" and press the SET button to enter the submenu. The product information including product, Thermal Resolution, HWV, SYSV and SD can be viewed.

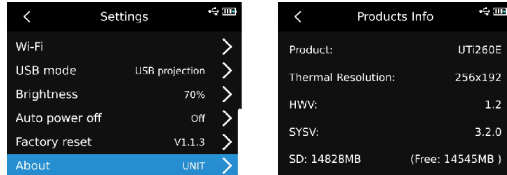

## 12. Image Viewing

In the main interface, press the image viewing button to enter the multimedia browsing interface. Press the up/down button to select all photos or other folders, and press the SET button to open the selected folder. Press the up/down/left/right button to select the image to be viewed, and press the SET button to view this image. Press the left/right button to switch between images.

When viewing an image, press the SET button to open the submenu of this image. The functions in this submenu are:

Message: create date, ModifiedDate, Emissivity, HVGA, Ambient Temp., Relative Humidity, ReflectiveDistance, QR code, remarks.

Notes: The added notes will show in the photo message.

Redact: markup, image, palette, measure, Isotherm.

QR code: Users can add an existing QR code for image classification, or can delete the QR code of the current image or add a new QR code.

Delete.

Note: In the redact interface, after editing a photo, press the SET button and then the up button to select "restore". Press the SET button again to restore the photo to its original state. Press the return button after editing, and a box "save/exit/esc" will pop up. Select Exit to exit the editing interface. Select Save and a box "Cover?" will pop up. Select Cover, the original image will be changed and saved. Select New, the original image will not be changed and a new image will be saved.

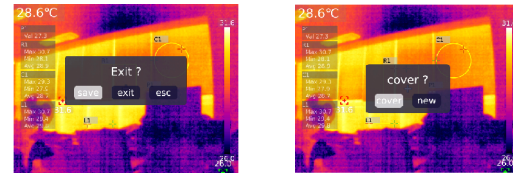

After adding the QR code, press the return button, and a prompt "Save and exit" will pop up. Choose Confirm to save the added QR code. Choose Cancel to exit the QR code editing page without saving. The QR code added here will not be saved to the existing QR code category. If users want to modify the existing QR code, they need to change it in the settings.

## 13. Buttons

In the main interface, press the up button to zoom in. The magnification is displayed in the upper right corner of the screen, and it will step through 1X, 2X, 4X, and 1X.

In the main interface, press the left/right button to adjust the degree of fusion. The optional degrees are 0%, 25%, 50%, 75%, and 100%.

## 14. SD Card

This device supports Micro SD card to store images. To avoid affecting the operating speed of the device, please copy the backup data regularly and clean up the SD card in time. To avoid causing abnormal data on the SD card, do not insert or remove the SD card repeatedly. If the SD card is removed in the image viewing interface, a box "SD lost" will pop up.

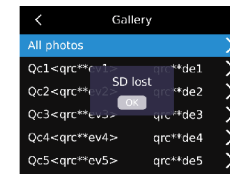

## 15. Maintenance

Use a wet cloth or weak soap solution to clean the outer shell of the device. Do not use abrasives, isopropyl alcohol or solvents to clean the outer shell, lens or window.

## 16. Safety Instructions

In order to ensure the accuracy, please read the instructions carefully. Please use this product in accordance with the manual; otherwise the free warranty will not be carried out if the product is damaged. Please do not use this device in flammable, explosive, steamy, humid or corrosive environments. Please do not continue to use the device when it is damaged, broken or corrected, so as to avoid incorrect test results. Please refer to the emissivity information to confirm the actual temperature; otherwise the measured temperature will be inaccurate.

Do not aim the lens at a strong or hot light source, such as the sun and other high-temperature objects, so as to avoid damage to the lens or thermal imaging detector.

Do not use the product in extremely hot, cold, dusty or high humidity environments. For detailed temperature and humidity requirements, please refer to the parameter table.

The product can be charged with a USB cable. However, in order to improve the charging efficiency, it is recommended to pull out the battery pack and charge the battery pack separately.

## 17. FCC Compliance statement

This device complies with Part 15 of the FCC Rules. Operation is subject to the following two conditions: (1) this device may not cause harmful interference, and (2) this device must accept any interference received, including interference that may cause undesired operation.

## 18. Common Emissivity

Material	Emissivity	Material	Emissivity
Wood	0.85	Black paper	0.86
Water	0.96	Polycarbonate	0.8
Brick	0.75	Concrete	0.97
Stainless steel	0.14	Copper oxide	0.78
Tape	0.96	Cast iron	0.81
Aluminum plate	0.09	Rust	0.8
Copper plate	0.06	Gypsum	0.75
Black aluminum	0.95	Paint	0.9
Human skin	0.98	Rubber	0.95
Asphalt	0.96	Soil	0.93
PVC	0.93		

**UNI-T®**

**UNI-TREND TECHNOLOGY (CHINA) CO., LTD.**

No. 6, Gong Ye Bei 1st Road,  
Songsan Lake National High-Tech Industrial  
Development Zone, Dongguan City,  
Guangdong Province, China